

Control and Automation

For industrial applications ED.03

Contactors for capacitors switching

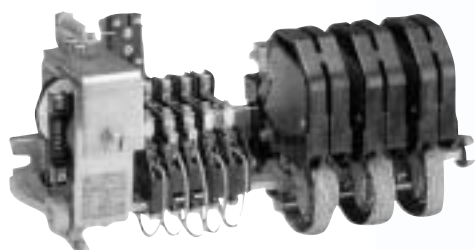
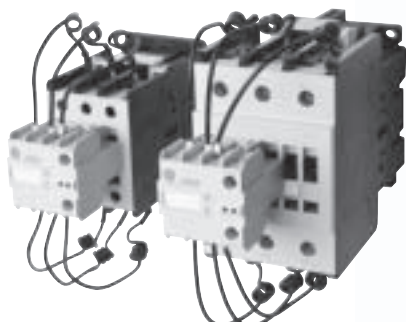

Series M - Minicontactors

- C.3 Order codes
- C.23 Technical data
- C.29 Terminal numbering
- C.50 Dimensions

Series CL - Contactors

- C.11 Order codes
- C.31 Technical data
- C.39 Terminal numbering
- C.52 Dimensions

Series CK - Contactors

- C.19 Order Codes
- C.42 Technical data
- C.58 Dimensions

Plug-in relays and Auxiliary contactors

Series MT0 - Thermal overload relays for minicontactors

- C.61 Order codes
- C.68 Technical data
- C.69 Dimensions

Motor protection devices

Contactors and Thermal overload relays

Series RT - Thermal overload relays for contactors

- C.63 Order codes
- C.70 Technical data
- C.74 Dimensions

Motorstarters

Control and signalling units

Series RE - Electronic overload relays

- C.66 Order codes
- C.77 Technical data
- C.78 Dimensions

NEW

Electronic relays

Limit switches

Series CSCN - Contactors for capacitors

- C.81 Order codes
- C.82 Technical data
- C.84 Dimensions

NEW

Speed drive units

Main switches

Series 390.R - Clapper contactors

- C.87 Order codes
- C.93 Technical data
- C.96 Dimensions

Numerical index



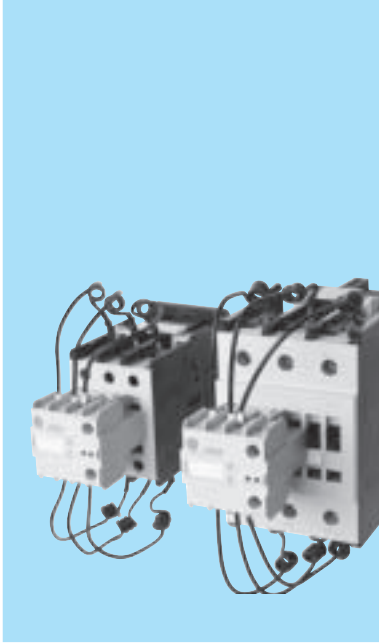

Contactors for capacitors switching

With built-in resistance to switch three phase capacitor banks

“CSCN” contactors incorporate a front block with three early-make auxiliary contacts together with 6 quick discharge resistors (two per phase) through which the capacitors are switched to the network, reducing the current peak. Once the resistors have damped the current peak, the main contacts short-circuit the resistors, carrying the uninterrupted current. A few milliseconds later the early-make auxiliary contact closes to guarantee that all current flows through the main contacts.

Standards / Marking

IEC/EN 60947-1	CENELEC HD 419
IEC/EN 60947-4-1	VDE 0660/102
IEC/EN 60947-5-1	NFC 63-110
EN 50005	ASE 1025
UL 508	UNE 20109
CSA C22.2/14	

Approvals



Standard voltages

To complete the catalogue number, replace the symbol ♦ by the code corresponding to the voltage and frequency of the control circuit, other voltages on request.

Alternating current (V). Dual-frequency

♦	1	2	3	4	5	6	7	8	9
50/60Hz	24	42	110	120	220	230	240	440	48
			115						

Alternating current (V)

♦	E	K	L	N	T	U	W	Y	Z
50Hz	32	127		220		380	415	500	660
				230		400			690
60Hz			208	277	380	480	460	600	

A

B

C

D

E

F

G

H



I

X

Order codes ● pg. C.81
 Technical data ● pg. C.82
 Dimensional drawings ● pg. C.84



Contactors for capacitors switching

Ith	Ambient temperature										Fuse gI - gG	Contacts		Cat. no. ⁽¹⁾	Ref. no. see bottom	Pack
	$\theta \leq 55^{\circ}\text{C}$					$\theta \leq 70^{\circ}\text{C}$.3 •4	•1 •2			
	230V 240V kvar	400V kvar	415V kvar	500V kvar	660V 690V kvar	230V 240V kvar	400V kvar	415V kvar	500V kvar	660V 690V kvar						
	25	7.5	12.5	13	16	15	3.7	7.5	8	9.5	10	25	2	0	CSCN12A320 ♦	1
													1	1	CSCN12A311 ♦	1
													0	2	CSCN12A302 ♦	1
	32	10	16.7	17	21	20	5	10	11	12.5	12.5	35	2	0	CSCN16A320 ♦	1
													1	1	CSCN16A311 ♦	1
													0	2	CSCN16A302 ♦	1
	45	12.5	20	21	25	25	7.5	12.5	13	16	15	40	1	0	CSCN20A310 ♦	1
													0	1	CSCN20A301 ♦	1
													2	1	CSCN20A321 ♦	1
													1	2	CSCN20A312 ♦	1
	45	15	25	26	31	30	10	15	16	18	20	50	1	0	CSCN25A310 ♦	1
													0	1	CSCN25A301 ♦	1
												2	1	CSCN25A321 ♦	1	
												1	2	CSCN25A312 ♦	1	
60	20	30	31	38	35	16	22	23	27	25	63	1	0	CSCN30A310 ♦	1	
												0	1	CSCN30A301 ♦	1	
												2	1	CSCN30A321 ♦	1	
												1	2	CSCN30A312 ♦	1	
90	25	45	47	56	55	20	35	36	44	40	80	1	0	CSCN45A310 ♦	1	
												0	1	CSCN45A301 ♦	1	
												2	0	CSCN45A320 ♦	1	
												1	1	CSCN45A311 ♦	1	
												1	2	CSCN45A312 ♦	1	
110	35	55	57	69	65	30	45	47	56	50	125	1	0	CSCN55A310 ♦	1	
												0	1	CSCN55A301 ♦	1	
												2	0	CSCN55A320 ♦	1	
												1	1	CSCN55A311 ♦	1	
												1	2	CSCN55A312 ♦	1	
140	45	70	73	88	85	35	60	62	75	70	160	1	0	CSCN70A310 ♦	1	
												0	1	CSCN70A301 ♦	1	
												2	0	CSCN70A320 ♦	1	
												1	1	CSCN70A311 ♦	1	
												1	2	CSCN70A312 ♦	1	
	Spare coils															
	For series CSCN12 ... CSCN25												LB1A ♦	5		
	For series CSCN30												LB3A ♦	5		
For series CSCN45 ... CSCN70												LB4A ♦	5			

(1) To complete the reference, replace ♦ by the code corresponding to the voltage and frequency of the control circuit. (see pg. C.80)

Order codes

A

B

C

D

E

F

G

H

I

X



Technical data

Technical characteristics

			CSCN12	CSCN16	CSCN20	CSCN25	CSCN30	CSCN45	CSCN55	CSCN70
Main circuit (poles)										
Rated operational voltage	(V)		690	690	690	690	690	690	690	690
Rated insulation voltage according to IEC947	(V)		1000	1000	1000	1000	1000	1000	1000	1000
Rated thermal current	(A)		25	32	45	45	60	90	110	140
Max. power utilization at 55°C	230/240V	(kvar)	7,5	10	12,5	15	20	25	35	45
	380/400V	(kvar)	12,5	16,7	20	25	30	45	55	70
	660/690V	(kvar)	15	20	25	30	35	55	65	85
Electrical endurance	(ops.)		280.000	280.000	280.000	250.000	200.000	150.000	120.000	90.000
Max. ops./hour	(ops./hour)		350	350	350	240	240	150	150	150
Control circuit										
Standard voltages	50Hz	(V)	24-690	24-690	24-690	24-690	24-690	24-690	24-690	24-690
	60Hz	(V)	24-600	24-600	24-600	24-600	24-600	24-600	24-600	24-600
Consumption										
Single frequency	Mar. circuit open	(VA)	45	45	48	48	88	191	191	198
	Mar. circuit closed	(VA)	6	6	7	7	9	15,5	15,5	17
Dual frequency	Mar. circuit open	(VA)	54	54	58	58	125	245	245	250
	Mar. circuit closed	(VA)	7	7	8	8	11,5	20	20	23
50Hz	Mar. circuit open	(VA)	35	35	39	39	110	215	215	220
	Mar. circuit closed	(VA)	5	5	6	6	11	15	15	19

Instantaneous auxiliary contact blocks

Rated insulation voltage Ui	(V)									1000
Rated thermal current Ith	(A)									10

Ambient conditions

Storage temperature	(°C)									-50 ... +80
Operating temperature	(°C)									-25 to +55 (without derating)
Altitude up to 3000m										Nominal values
Mounting positions										Vertical mounting +/- 30°

Terminal capacity and tightening torque

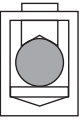
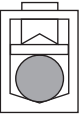
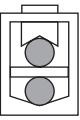
		CSCN12	CSCN16	CSCN20	CSCN25	CSCN30	CSCN45	CSCN55	CSCN70
	Solid, stranded and finely stranded without end sleeve (mm²)	1 x 0.5 ... 2,5		1 x 0.5 ... 2,5		-	-	-	-
	Finely stranded with or without end sleeve (mm²)	1 x 1 ... 2,5		1 x 1 ... 2,5		-	-	-	-
	AWG wires	1 x 20 ... 12		1 x 20 ... 8		-	-	-	-
	Tightening torque (Nm)	1.6		2.2		-	-	-	-
	(Lb x in.)	15		20		-	-	-	-
	Solid, stranded and finely stranded without end sleeve (mm²)	-		-		0.75 ... 16	1 ... 35	1.5 ... 50	
	Finely stranded with end sleeve (mm²)	-		-		0.75 ... 16	1 ... 35	1.5 ... 50	
	Finely stranded without end sleeve (mm²)	-		-		1 ... 16	1 ... 35	1.5 ... 50	
	AWG wires	-		-		18 ... 6	16 ... 2	16 ... 2	
	Tightening torque (Nm)	-		-		1.8	4	5.6	
(Lb x in.)	-		-		16	35	50		
	Solid (mm²)	-		-		0.75 ... 16	1 ... 16	4 ... 35	
	Stranded (mm²)	-		-		0.75 ... 16	1 ... 25	4 ... 35	
	Finely stranded without end sleeve (mm²)	-		-		0.75 ... 16	1 ... 25	4 ... 35	
	Finely stranded with end sleeve (mm²)	-		-		1 ... 16	1 ... 25	4 ... 35	
	AWG wires	-		-		18 ... 6	16 ... 4	10 ... 1	
Tightening torque (Nm)	-		-		1.8	4	5.6		
(Lb x in.)	-		-		16	35	50		
	Solid, stranded and finely stranded without end sleeve (mm²)	-		-		Max. 16	Max. 50 ... 4	Max.	
	Finely stranded without end sleeve (mm²)	-		-		Max. 16	Max. 25 ... 16	50 ... 35	
	Finely stranded with end sleeve (mm²)	-		-		Max. 16	Max. 35 ... 2,5	Max. 35	
	AWG wires	-		-		Max. 6	Max. 25 ... 16	Max. 25 ... 25	
	Tightening torque (Nm)	-		-		1.8	4	5.6	
(Lb x in.)	-		-		16	35	50		

Standard contactors

Series "CL" and "CK" contactors, to switch three phase capacitor banks

Electrical endurance: >100,000 operations

Contactor		$\theta \leq 55^{\circ}\text{C}$					$\theta \leq 70^{\circ}\text{C}$					Fuse	I max.
Type ⁽¹⁾	Ith	220V 230V 240V kvar	400V kvar	415V kvar	500V kvar	690V 660V kvar	220V 230V 240V kvar	400V kvar	415V kvar	500V kvar	690V 660V kvar	gl - gG	(peak)
	A										A	A	
CL00A	25	3	5	5.5	6.5	5.7	2.4	4	4.5	5.2	4.5	10	1000
CL01A	25	4.5	9.5	10.5	12.5	11	3.6	6	6.5	10	7	16	1000
CL02A	32	6.5	11	12	14.5	12.5	5.2	8.5	9	11.5	10	25	1000
CL25A	45	7.5	12.5	14	16	15	6.5	10	11	13	12	25	1000
CL03A	45	9	15	16.5	20	17.5	7.2	12	13	16	14	35	2500
CL04A	60	12.5	21	23	27.5	24	10	17	18	22	19.5	40	2500
CL45A	60	16.5	25	27	32	30	13	20	22	25	22	50	2500
CL06A	90	22	40	43	52	50	17	30	33	41	35	80	3500
CL07A	110	25	45	48	58	65	19	35	37	46	40	125	3500
CL08A	110	30	50	54	65	70	22	40	43	52	50	125	3500
CL09A	140	40	65	70	85	95	35	58	62	75	85	160	3500
CL10A	140	50	80	85	105	120	43	70	75	90	105	160	3500
CK75C	250	60	110	118	145	150	48	88	94	116	120	250	5000
CK08C	250	70	125	135	162	170	56	100	107	130	136	250	5000
CK85B	315	80	150	160	195	200	64	120	130	156	160	315	5000
CK09B	315	95	165	177	215	230	85	148	160	192	205	315	5000
CK95B	450	105	190	205	250	288	95	175	188	230	265	450	5500
CK10C	600	135	260	280	340	370	120	235	252	375	330	630	10000
CK11C	700	190	325	350	425	450	152	260	280	340	360	800	10000
CK12B	1000	250	400	430	520	600	200	320	344	416	480	1000	12000
CK13B	1250	315	525	565	685	650	252	420	452	548	520	1250	15000

(1) To complete contactor reference, see C.10 for CL and C.18 for CK



Dimensional drawings

Contactors for capacitors switching

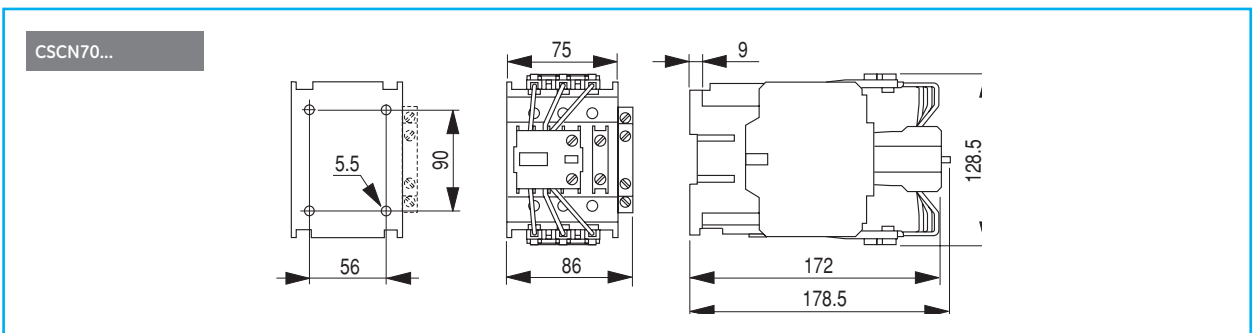
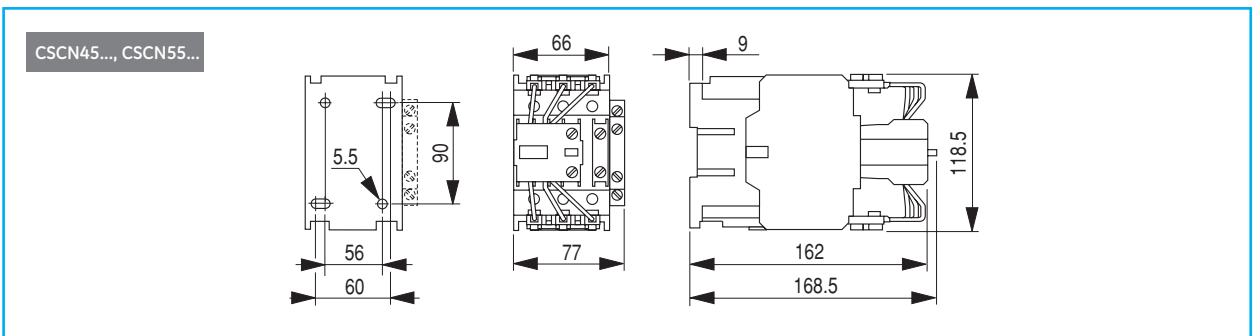
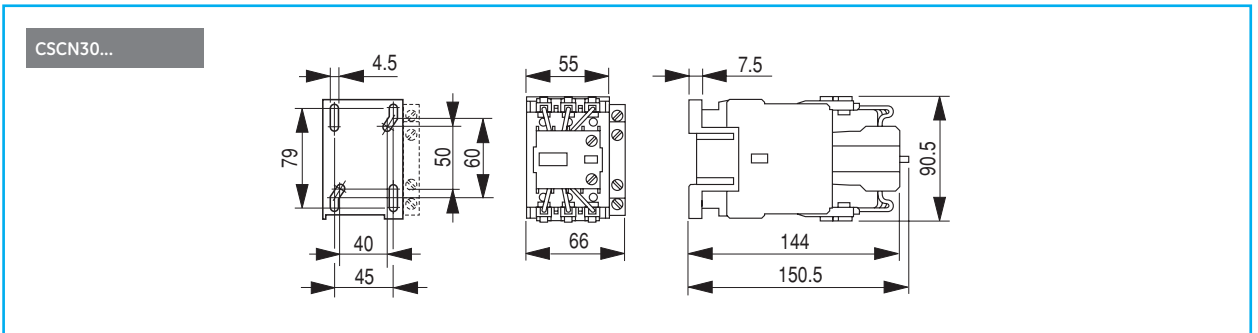
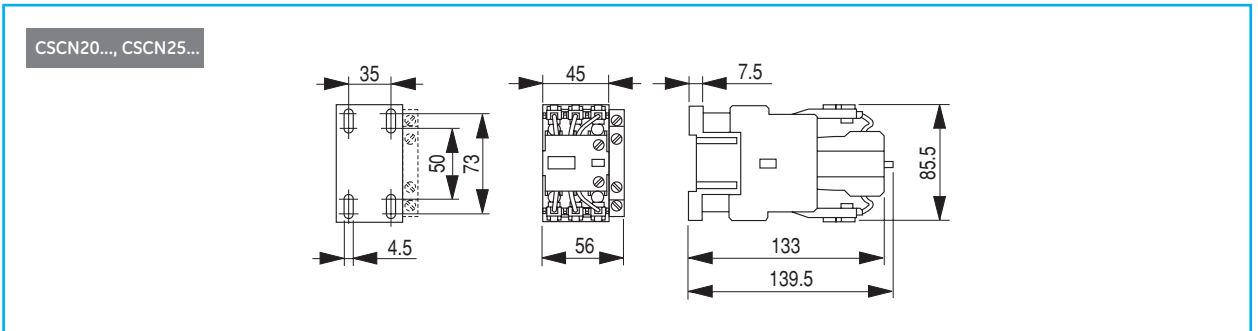
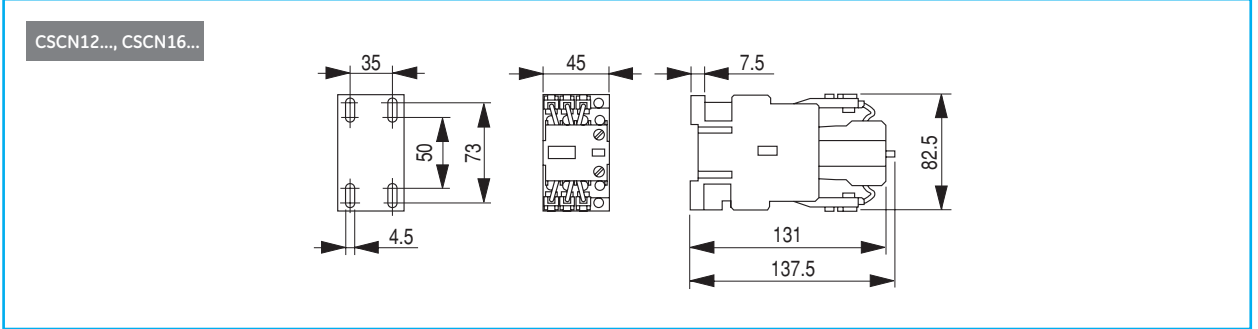

Notes

Grid area for notes.

Dimensions

A
B
C
D
E
F
G
H
I
X



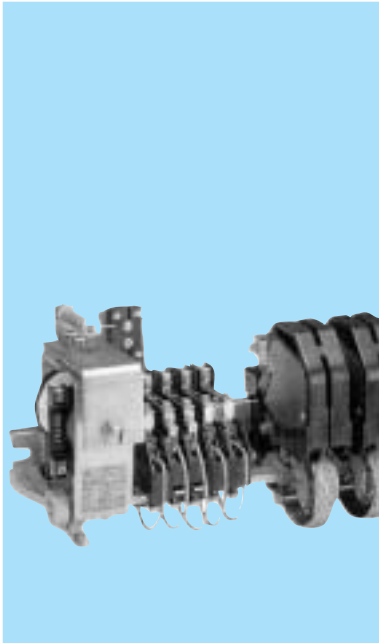

Clapper contactors 40A to 800A (AC-3) / 45A to 1200A (AC-1)

AC and DC control using a bridge rectifier, designed to meet the most recent stringent requirements in terms of reliability, service life and performance.

Main characteristics

- Sliding contact holder, set on self-centering and self-lubricating bronze bushings
- Minitubes made of high-strength, high electrical resistance material
- Individual auxiliary contacts

Construction

Variable composition contactors (the number of main poles and auxiliary contacts may vary), preferably secured on mounts

Control circuit

Solid iron magnetic circuit with coil powered by direct or rectified current, particularly for heavy-duty applications (e.g., cranes, roll mills, reversing winches, etc.).

The coils are sized for intermittent operation. For continuous operation, insert an economy resistor in series with the coil using the respective auxiliary contact.

Main contacts

The sintered main contacts are classified as Type 4/2 for intermittent operation and Type 5/2 for continuous operation.

The 4/2 sintered contact may be used only for heavy-duty operation when the number of switching operations per hour is above 60 and the operating intermittence is equal or less than 60% (cranes, roll mills, etc.).

If used for continuous operation, the contact will overheat.

The 5/2 sintered contact may be used only for normal duty when the number of switching operations per hour is equal to or less than 60% and the operating intermittence is above 60%.

Auxiliary contacts

Individual NO or NC single-broke contacts
Possibility to advance or delay contact making or breaking

Special versions

The following items may be supplied upon request:

- Contactors with coils having an operating limit that exceeds the limits required by the standards
- Contactors with an operating voltage up to 3000V (rotary disconnect switches, induction furnaces, etc.)
- Vertical mechanical interlocks ideal for interlocking 3 contactors.

Spare parts and additional components

Spare parts and additional components for the contactors are listed on page C.91.

Standards

IEC/EN 60947-1
IEC/EN 60947-4-1
IEC/EN 60947-5-1

Standard voltages

Alternating current (V) Dual-frequency coils

	AP	CP	EP	GP
50/60Hz	24	48	110	220

Direct current (V)

	A	B	C	D	E	F	G	H	M	R
Voltage	20	24	40	48	97	110	197	220	230	125

Order codes ● pg. C.87

Coils ● pg. C.90

Spare parts ● pg. C.91

Technical data ● pg. C.94

Dimensional drawings ● pg. C.96

Control voltage and normal combinations

Normal rated voltages, shaft spacing and combinations (main and auxiliary poles) have been defined for each switchgear unit, thereby allowing the contactor to be rapidly selected.

AC rated voltages: 24V - 48V - 110V - 220/230V

DC rated voltages: 24V - 48V - 110V - 220/230V

Spacing between standardised shafts and combinations:

See pages C.96 to C.98

Standard center-to-center spacing (mm): 150, 200, 250, 300, 350, 400, 450, 500, 600, 700, 800, 900, 1000

Main poles

The poles can be constructed as follows, depending on the operating conditions:

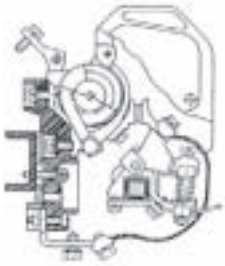

Z design (NO)

- For load breaking, with high breaking capacity
- For AC or DC use
- Equipped with magnetic arc-quenching coil. In the case of AC, the poles are normally supplied with an appropriate arc-quenching coil for the maximum rated current of the pole.
- Arc-quenching coils for medium rated currents with respect to the expected peak current are available for DC use upon request, for more effective pole performance (see table on page C.90).

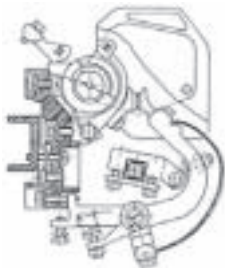

RN design (NC)

- Based on the use of break poles, which are open when the coil is energized and closed when the coil is de-energised.
- For AC or DC use in special circuits where high interrupting capacities are not required.
- This design is intended to be used with contactors R1, R2, R3, R4, R5, R7.

Poles	R1	R2	R3	R4	R5	R6	R7	R8	R9
Z	■	■	■	■	■	■	■	■	■
RN	■	■	■	■	■		■		

Order codes - Clapper contactors

Peak operating current		AC-3 admissible rated powers				Electric endurance	AC or DC	Pack.
Resistive loads	Motors <440V, 3 ~ 50/60Hz	220V 230V	380V 400V	415V 440V	500V			
AC1 A	AC3 A	kW HP	kW HP	kW HP	kW HP	Cat. AC3 Switching operations	See the following pages C.84 and C.85 on how to complete the catalogue number	
45	40	11,5	20	20	20	1 × 10 ⁶	R1 ...	1
90	90	26	45	45	45	1 × 10 ⁶	R2 ...	1
125	120	36.5	62	62	73.5	1 × 10 ⁶	R3 ...	1
250	200	72.5	100	100	120	1 × 10 ⁶	R4 ...	1
320	320	93	160	160	165	1.2 × 10 ⁶	R5 ...	1
450	450	130	225	225	300	1.5 × 10 ⁶	R6 ...	1
630	630	184	315	315	400	1 × 10 ⁶	R7 ...	1
800	800	232	400	400	500	0.9 × 10 ⁶	R8 ...	1
1500	-	-	-	-	-	-	R9 ...	1

Catalogue number structure

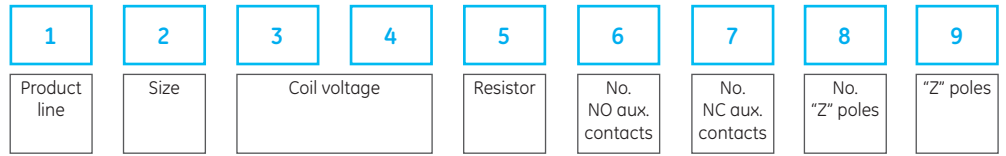

A

B

C

D

E

F

G

H

I

X

Size		1	2
1	Max.	45	R 1
	500V AC	90	R 2
2	250V DC	125	R 3
		250	R 4
		320	R 5
		450	R 6
		630	R 7
		800	R 8
		1200	R 9

Auxiliary contacts		6	7
6	NO		
	1	1	
	2	2	
	3	3	
	4	4	
	5	5	
7	6	6	
		1	1
		2	2
		3	3
	4		

"RN" poles" (NC)		11
"RN" poles	"RN" poles	
0	0	-
1	1	1
2	2	2
3	3	3
4	4	4

Note: The "RN" poles are not available for the R6, R8 and R9 types.

Coil voltage		3	4
AC	DC		
Types R1 ... R7			
24V		A	P
48V		C	P
110V		E	P
220V		G	P
	20V	A	-
	24V	B	-
	40V	C	-
	48V	D	-
	97V	E	-
	110V	F	-
	197V	G	-
	220V	H	-
	230V	M	-
	125V	R	-
Types R8 and R9			
110V		E	P
220V	97V	G	P
	110V	E	-
	197V	F	-
	220V	G	-
	230V	H	-
	125V	M	-

"Z" poles" (N)		8
"Z" poles	"Z" poles	
0	0	-
1	1	1
2	2	2
3	3	3
4	4	4

"RN" poles		12
Type of pole		
RN		V
No "RN" poles		-

Note: The "RN" poles are not available for the R6, R8 and R9 types.

Economy resistor		5
	If required (5/2 contacts)	R
	If not required	-

"Z" poles		9
Type of pole		
Z		Z
No "Z" poles		-

Arc-quenching coil "Z" poles		Standard Upon request		
Type		A	B	C
R1	45A	14A	25A	
R2	90A	45A	-	
R3	125A	75A	-	
R4	200A	50A	130A	
R5	320A	150A	-	
R6	450A	270A	-	
R7	630A	320A	-	
R8	800A	320A	400A	
R9	1200A	-	-	

Arc-quenching coil «RN» poles		Standard Upon request		
Type		A	B	C
R1	45A	14A	25A	
R2	90A	45A	-	
R3	125A	75A	-	
R4	200A	50A	130A	
R5	320A	150A	-	
R6	-	-	-	
R7	630A	320A	-	
R8	-	-	-	
R9	-	-	-	

Note: The "RN" poles are not available for the R6, R8 and R9 types.

Type of contacts		14
Type		
4/2	Intermittent op.	4
5/2	Continuous op.	5



10	11	12	13	14	15	16	17	18
Arc-quenching coil "Z" poles	No. "RN" poles	"RN" poles	Arc-quenching coil "RN" poles	Type of contacts	Stationary support	Space	Shaft	Isolation

	Stationary support	Contactor type			
		R1 R2 R3	R4 R5	R6 R7 R8	R9
15	Length (mm)				
	150	A	-	-	-
	200	B	-	-	-
	250	C	C	-	-
	300	D	D	-	-
	350	E	E	E	-
	400	F	F	F	F
	450	G	G	G	G
	500	H	H	H	H
	600	I	I	I	I
	700	L	L	L	L
	800	M	M	M	M
	900	N	N	N	N
	1000	O	O	O	O

	Shaft (≤stat. sup.)	Contactor type			
		R1 R2 R3	R4 R5	R6 R7 R8	R9
17	Length (mm)				
	150	A	-	-	-
	200	B	-	-	-
	250	C	C	-	-
	300	D	D	-	-
	350	E	E	E	-
	400	F	F	F	F
	450	G	G	G	G
	500	H	H	H	H
	600	I	I	I	I
	700	L	L	L	L
	800	M	M	M	M
	900	N	N	N	N
	1000	O	O	O	O

	Isolation	18
18	For more isolation	M
	Not required	-

	Space	16
16	No space	Station. sup.=Shaft -
	Space	Left S
		Right -

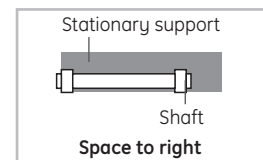
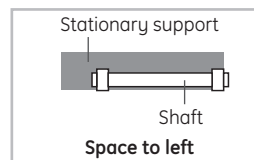
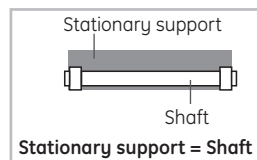

Order codes

A

B

C

D

E

F

G

H

I

X



Standardised DC or rectified coils

The DC coils are suitable for intermittent operation; for continuous operation, an economy resistor must be used.
The coils for rectified rated voltages 20-40-97-197V obtained from AC power supplies. (before the rectifier). 24-48-110-220V are available upon request. For the contactor of "RN" break poles, contact GE.

Clapper contactors

A

B

C

D

E

F

G

H

I

X

Contactor	Voltage VDC	Coil		Economy resistor for continuous operation ± 5%				Single-phase bridge rectifier for AC power		
		Cat. no.	Ref. no.	W	Ω	Cat. no.	Ref. no.	V 50/60Hz	Cat. no.	Ref. no.
R1 R2	20	39012Y20D	244107	4	8.2	RSS13/64TA8,2	204177	24	MSK-B250/220-1,5	209997
	24	39012Y24D	202327		18	RSS13/64TA18	211727	-		
	40	39012Y40D	244106		33	RSS13/64TA33	211728	48		
	48	39012Y48D	244734		68	RSS13/64TA6,8	214869	-		
	97	39012Y97D	202328		220	RSS13/64TA220	212702	110		
	110	39012Y110D	202323		330	RSS13/64TA330	211745	-		
	197	39012Y197D	202325		680	RSS13/64TA680	214580	220		
	220	39012Y220D	202326		1200	RSS13/64TA1200	213034	-		
	230	39012Y230D	211706		1200	RSS13/64TA1200	213034	-		
	125	39012Y125D	202324		330	RSS13/64TA300	211714	-		
R3	20	3903Y20D	215278	4	8.2	RSS13/64TA8,2	204177	24	MSK-B250/220-1,5	209997
	24	3903Y24D	244735		18	RSS13/64TA18	211727	-		
	40	3903Y40D	244088		39	RSS13/64TA39	211730	48		
	48	3903Y48D	212705		47	RSS13/64TA47	211731	-		
	97	3903Y97D	213691		270	RSS13/64TA270	214399	110		
	110	3903Y110D	202437		330	RSS13/64TA330	211745	-		
	197	3903Y197D	214442		820	RSS13/64TA820	214400	220		
	220	3903Y220D	202438		1200	RSS13/64TA1200	213034	-		
	230	3903Y230D	211107		1200	RSS13/64TA1200	213034	-		
	125	3903Y125D	216100		330	RSS13/64TA300	211714	-		
R4	20	3904Y20D	244084	6	8.2	RSS13/64TA8,2	204177	24	MSK-B250/220-1,5	209997
	24	3904Y24D	202483		18	RSS13/64TA18	211727	-		
	40	3904Y40D	244083		33	RSS13/64TA33	211728	48		
	48	3904Y48D	213814		33	RSS13/64TA33	211728	-		
	97	3904Y97D	213601		180	RSS13/64TA180	211744	110		
	110	3904Y110D	202479		180	RSS13/64TA180	211744	-		
	197	3904Y197D	202481		680	RSS13/64TA680	214580	220		
	220	3904Y220D	202482		680	RSS13/64TA680	214580	-		
	230	3904Y230D	211708		680	RSS13/64TA680	214580	-		
	125	3904Y125D	202480		180	RSS13/64TA180	211744	-		
R5	20	3905Y20D	244073	10	6.8	RSS13/64TA6,8	214869	24	SKB-B80/70-4	211716
	24	3905Y24D	244072		10	RSS13/64TA10	211742	-		
	40	3905Y40D	244071		27	RSS13/64TA27	244192	48		
	48	3905Y48D	244736		27	RSS13/64TA27	244192	-		
	97	3905Y97D	202513		120	RSS13/64TA120	243281	110		
	110	3905Y110D	202512		180	RSS13/64TA180	211744	-		
	197	3905Y197D	244074		470	RSS13/64TA470	244191	220		
	220	3905Y220D	212706		680	RSS13/64TA680	214580	-		
	230	3905Y230D	211709		680	RSS13/64TA680	214580	-		
	125	3905Y125D	242260		180	RSS13/64TA180	211744	-		
R6	20	3906Y20D	244065	10	6.8	RSS13/64TA6,8	214869	24	SKB-B80/70-4	211716
	24	3906Y24D	244064		8.2	RSS13/64TA8,2	204177	-		
	40	3906Y40D	244063		27	RSS13/64TA27	244192	48		
	48	3906Y48D	212707		27	RSS13/64TA27	244192	-		
	97	3906Y97D	202533		100	RSS13/64TA100	211744	110		
	110	3906Y110D	202532		180	RSS13/64TA180	211744	-		
	197	3906Y197D	244066		470	RSS13/64TA470	244191	220		
	220	3906Y220D	213612		680	RSS13/64TA680	214580	-		
	230	3906Y230D	211770		680	RSS13/64TA680	214580	-		
	125	3906Y125D	211711		180	RSS13/64TA180	211744	-		
R7	20	3907Y20D	244058	16	5.6	RSS13/64TA5,6	211735	24	SKB-B80/70-4	211716
	24	3907Y24D	244057		5.6	RSS13/64TA5,6	211735	-		
	40	3907Y40D	244056		15	RSS13/64TA15	211737	48		
	48	3907Y48D	244737		18	RSS13/64TA18	211727	-		
	97	3907Y97D	244738		82	RSS13/64TA82	204177	110		
	110	3907Y110D	202547		100	RSS13/64TA100	211743	-		
	197	3907Y197D	244059		330	RSS13/64TA330	211745	220		
	220	3907Y220D	202548		390	RSS13/64TA390	211746	-		
	230	3907Y230D	211712		1200	RSS13/64TA1200	213034	-		
	125	3907Y125D	211713		330	RSS13/64TA330	211745	-		
R8	97	3908Y97D	212959	16	82	RSS20/165TA82	214081	110	SKB-B250/220-4	212165
	110	3908Y110D	202565		120	RSS20/165TA120	213664	-		
	197	3908Y197D	214066		390	RSS20/165TA390	211748	220		
	220	3908Y220D	202566		470	RSS20/165TA470	211739	-		
R9	97	3909Y97D	214146	140	100	RSS20/165TA100	213663	110	SKB-B30/08	211720
	110	3909Y110D	202572		150	RSS20/165TA150	215004	-		
	197	3909Y197D	204181		390	RSS20/165TA390	211748	220		
	220	3909Y220D	244739		560	RSS20/165TA560	244987	-		

(1) To insert the resistors, use NC auxiliary contacts in series.

(2) Two 20x165 resistors connected in parallel, each with a resistive value listed in the table.



Spare parts

Contactora	Description	Cat. no.	Ref. no.	Pack (units)	
R1	"Z" stationary part with 14A arc-quenching coil and spark suppressor	390/3921PFZCS14	202273	1	
	"Z" stationary part with 25A arc-quenching coil and spark suppressor	390/3921PFZCS25	244172	1	
	"Z" stationary part with 45A arc-quenching coil and spark suppressor	390/3921PFZCS45	202274	1	
	"RN" stationary part with spark suppressor	390/3921PFRN	244173	1	
	"Z" moving part (with pressure spring and strap)	390/3921PMZI	202276	1	
	"RN" moving part (with pressure spring and strap)	390/3921PMRN	202275	1	
	Stationary and moving main contact, type 4/2 (intermittent operation)	390/3921/2FOM4/2	214120	1	
	Stationary and moving main contact, type 5/2 (continuous operation)	390/3922FOM5/2	214121	1	
	Spark suppressor for "Z" and "RN" poles	390/3921PZ	202277	1	
	R2	"Z" stationary part with 45A arc-quenching coil and spark suppressor	390/3922PFZCS45	244744	1
"Z" stationary part with 90A arc-quenching coil and spark suppressor		390/3922PFZCS90	202278	1	
"RN" stationary part with spark suppressor		390/3922PFRN	212709	1	
"Z" moving part (with pressure spring and strap)		390/3922PMZI	202279	1	
"RN" moving part (with pressure spring and strap)		390/3922PMRN	213014	1	
Stationary and moving main contact, type 4/2 (intermittent operation)		390/3921/2FOM4/2	214120	1	
Stationary and moving main contact, type 5/2 (continuous operation)		390/3922FOM5/2	214121	1	
Spark suppressor for "Z" and "RN" poles		390/3922PZ	202280	1	
R3		"Z" stationary part with 75A arc-quenching coil and spark suppressor	390/3923PFZCS75	244745	1
		"Z" stationary part with 125A arc-quenching coil and spark suppressor	390/3923PFZCS125	202281	1
	"RN" stationary part with spark suppressor	390/3923PFRN	213986	1	
	"Z" moving part (with pressure spring and strap)	390/3923PMZI	202283	1	
	"RN" moving part (with pressure spring and strap)	390/3923PMRN	202282	1	
	Stationary and moving main contact, type 4/2 (intermittent operation)	390/3923/2FOM4/2	214122	1	
	Stationary and moving main contact, type 5/2 (continuous operation)	390/3923FOM5/2	214123	1	
	Spark suppressor for "Z" and "RN" poles	390/3923PZ	202284	1	
	R4	"Z" stationary part with 125A arc-quenching coil and spark suppressor	390/3924PFZCS125	202288	1
		"Z" stationary part with 200A arc-quenching coil and spark suppressor	390/3924PFZCS200	202289	1
"RN" stationary part with spark suppressor		390/3924PFRN	202287	1	
"Z" moving part (with pressure spring and strap)		390/3924PMZI	202291	1	
"RN" moving part (with pressure spring and strap)		390/3924PMRN	202290	1	
Stationary main contact, type 4/2 (intermittent operation)		390/3924F4	214124	1	
Moving main contact, type 4/2 (intermittent operation)		390/3924M4/2	214126	1	
Stationary main contact, 5/2 type (continuous operation)		390/3924F5/2	204178	1	
Moving main contact, type 5/2 (continuous operation)		390/3924M5/2	214127	1	
Spark suppressor for "Z" and "RN" poles		390/3924PZ	202292	1	
R5	"Z" stationary part with 125A arc-quenching coil and spark suppressor	390/3925PFZCS150	213573	1	
	"Z" stationary part with 320A arc-quenching coil and spark suppressor	390/3925PFZCS320	202295	1	
	"RN" stationary part with spark suppressor	390/3925PFRN	244746	1	
	"Z" moving part (with pressure spring and strap)	390/3925PMZI	202298	1	
	"RN" moving part (with pressure spring and strap)	390/3925PMRN	202297	1	
	Stationary main contact, type 4/2 (intermittent operation)	390/3925F4/2	214128	1	
	Moving main contact, type 4/2 (intermittent operation)	390/3925M4/2	214130	1	
	Stationary main contact, 5/2 type (continuous operation)	390/3925F5/2	214129	1	
	Moving main contact, type 5/2 (continuous operation)	390/3925M5/2	214131	1	
	Spark suppressor for "Z" and "RN" poles	390/3925PZ	202299	1	
R5	"Z" stationary part with 270A arc-quenching coil and spark suppressor	390/3926PFZCS270	202303	1	
	"Z" stationary part with 450A arc-quenching coil and spark suppressor	390/3926PFZCS450	213574	1	
	"Z" moving part (with pressure spring and strap)	390/3926PMZI	202304	1	
	Stationary main contact, type 4/2 (intermittent operation)	390/3926F4/2	214133	1	
	Moving main contact, type 4/2 (intermittent operation)	390/3926M4/2	214135	1	
	Stationary main contact, 5/2 type (continuous operation)	390/3926F5/2	214134	1	
	Moving main contact, type 5/2 (continuous operation)	390/3926M5/2	214136	1	
	Spark suppressor for "Z" and "RN" poles	390/3926PZ	202654	1	

Order codes

A

B

C

D

E

F

G

H

I

X



Spare parts (continued)

Contactors	Description	Cat. no.	Ref. no.	Pack (units)
R7	"Z" stationary part with 320A arc-quenching coil and spark suppressor	390/3927PFZCS320	202307	1
	"Z" stationary part with 630A arc-quenching coil and spark suppressor	390/3927PFZCS630	202308	1
	"RN" stationary part with spark suppressor	390/3927PFRN	202306	1
	"Z" moving part (with pressure spring and strap)	390/392PMZI	202310	1
	"RN" moving part (with pressure spring and strap)	390/3927PMRN	202309	1
	Stationary main contact, type 4/2 (intermittent operation)	390/3927F4/2	214137	1
	Moving main contact, type 4/2 (intermittent operation)	390/3927M4/2	214139	1
	Stationary main contact, 5/2 type (continuous operation)	390/3927F5/2	214138	1
	Moving main contact, type 5/2 (continuous operation)	390/3927M5/2	214140	1
	Spark suppressor for "Z" and "RN" poles	390/3927PZ	202311	1
R8	"Z" stationary part with 400A arc-quenching coil and spark suppressor	3908PFZCS400	202555	1
	"Z" stationary part with 800A arc-quenching coil and spark suppressor	3908PFZCS800	202562	1
	"Z" moving part (with pressure spring and strap)	3908PMZ	202563	1
	Stationary main contact, type 4/2 (intermittent operation)	3908F4/2	214144	1
	Moving main contact, type 4/2 (intermittent operation)	3908/9M4/2	214141	1
	Stationary main contact, 5/2 type (continuous operation)	3908F5/2	214145	1
	Moving main contact, type 5/2 (continuous operation)	3908/9M5/2	214142	1
	Spark suppressor for "Z" and "RN" poles	3908PZ	202564	1
R8	"Z" stationary part with 1200A arc-quenching coil and spark suppr.	3909PFZCS120	244983	1
	"Z" moving part (with pressure spring and strap)	3909PMZ	212962	1
	Stationary main contact, type 4/2 (intermittent operation)	3909F4/2	204179	1
	Moving main contact, type 4/2 (intermittent operation)	3908/9M4/2	214141	1
	Stationary main contact, 5/2 type (continuous operation)	3909F5/2	204180	1
Moving main contact, type 5/2 (continuous operation)	3908/9M5/2	214142	1	



Operating categories

			R1...	R2...	R3...	R4...	R5...	R6...	R7...	R8...	R9...	
AC-1	Peak operating current	40°C (A)	45	90	125	250	320	450	630	800	1200	
	at ambient temp. of:	55°C (A)	45	90	125	250	320	450	600	750	1200	
	(for all rated voltages)	70°C (A)	30	70	100	200	280	360	500	700	950	
	Max. operating power	230/220V (kW)	17	30	45	90	114	170	195	240	450	
	Resistor III	400/380V (kW)	29	55	75	155	196	310	330	410	750	
		440/415V (kW)	32	57	85	180	227	340	330	500	900	
		500V (kW)	39	69	102	200	250	390	420	550	1030	
Conductor		(mm ²)	10	35	50	120	185	2 x (30x5)	2 x (40x5)	2 x (60x5)	4 x (50x5)	
Operation in % of peak	120 ops/h	(%)	100	100	100	100	100	100	100	100	50	
operating current	300 ops/h	(%)	50	50	50	50	30	30	20	10	10	
AC-3	Peak operating current	Ue = 400V (A)	40	90	110	200	320	450	630	800	-	
	Max. operating power	230/220V (kW)	11.5	26	36.5	72.5	93	130	184	232	-	
		400/380V (kW)	20	45	62	100	160	225	315	400	-	
		440/415V (kW)	20	45	68	100	160	225	315	400	-	
		500V (kW)	20	45	72.5	120	165	280	400	500	-	
Use in % of peak	120 ops/h	(%)	100	100	100	100	100	100	100	100	-	
operating current	300 ops/h	(%)	50	50	50	50	50	50	30	30	-	
AC-4	Peak operating current	Ue = 500V (A)	18.5	44	55	110	125	150	165	250	-	
	Operating power	230/220V (kW)	4	11	15	33	37	45	50	80	-	
	(200,000 switching	(HP)	5.3	14.6	19.9	43.9	49.2	59.8	66.5	106	-	
		400/380V (kW)	9	22	28	55	63	80	90	132	-	
		(HP)	11.9	29.2	37.2	73.1	83.8	106	119.7	175.5	-	
		500V (kW)	11	25	33	75	90	100	110	225	-	
		(HP)	14.6	33.2	43.9	99.7	119.7	133	146	299	-	
Peak operating current	≤ 400V (A)	40	90	110	185	280	420	590	700	-		
Max. operating power	400/380V (kW)	18.5	38	55	90	150	220	300	375	-		
			R1...	R2...	R3...	R4...	R5...	R6...	R7...	R8...	R9...	
DC1 L/R ≤ 1ms	Ue	Series poles	R1...	R2...	R3...	R4...	R5...	R6...	R7...	R8...	R9...	
	125V	1	40	85	115	180	300	400	600	700	900	
		2	60	90	125	200	320	450	630	750	1000	
		3	60	90	125	200	320	450	630	800	1250	
		4	60	90	125	200	320	450	630	800	1250	
	220V	1	20	75	110	160	275	350	500	600	800	
		2	30	90	115	200	300	370	560	650	900	
		3	40	90	125	250	320	400	630	750	1000	
		4	40	90	125	250	320	450	630	800	1250	
	440V	1	-	-	-	-	-	-	-	-	-	
		2	-	75	100	200	275	350	500	600	800	
		3	20	90	125	250	320	400	600	700	900	
		4	20	90	125	250	320	450	630	800	1000	
DC3 L/R ≤ 2.5ms	125V	1	30	75	100	170	280	380	550	650	-	
		2	40	80	110	200	320	450	630	800	-	
		3	45	90	110	200	320	450	630	800	-	
		4	45	100	120	220	340	480	-	-	-	
		220V	1	-	-	-	-	-	-	-	-	
			2	15	65	90	155	245	340	460	550	-
			3	20	90	110	200	320	450	630	800	-
			4	25	90	110	200	320	450	630	800	-
		440V	1	-	-	-	-	-	-	-	-	-
			2	-	-	-	-	-	-	-	-	-
			3	10	55	75	120	200	300	400	500	-
			4	13	70	100	160	260	400	550	660	-
DC5 L/R ≤ 15ms	125V	1	27	50	70	90	240	320	400	500	-	
		2	35	70	90	150	280	380	450	550	-	
		3	40	90	100	200	320	420	500	600	-	
		4	40	90	110	200	320	450	500	650	-	
		220V	1	-	-	-	-	-	-	-	-	
			2	13	55	80	140	220	300	410	490	-
			3	18	80	100	180	290	400	560	700	-
			4	22	80	100	180	290	400	560	700	-
		440V	1	-	-	-	-	-	-	-	-	-
			2	-	-	-	-	-	-	-	-	-
			3	9	50	67	100	180	270	360	450	-
			4	11	60	90	130	224	360	480	600	-



Technical data

Standards

IEC/EN 60947-1
IEC/EN 60947-4-1
IEC/EN 60947-5-1

Ambient conditions

Storage temperature	-55°C to +80°C	
Operating temperature	-40°C to +60°C	
Altitude	up to 2500m	Rated values
	3000 to 4000m	90%Ie 80%Ue
	4000 to 5000m	80%Ie 75%Ue

Climatic withstand capacity (IEC 68-2)

Continuous testing 40/125/56			
Cold (72h)	Temperature	-40°C	
Dry heat (96h)	Temperature	+125°C	
	Relative humidity	< 50%	
Moist heat (56 days)	Temperature	+40°C	
	Relative humidity	95%	
Cyclic testing			
First half-cycle (12h)	Low temperature	+25°C	
	Relative humidity	93%	
Second half-cycle (12h)	Low temperature	+55°C	
	Relative humidity	95%	
No. consecutive cycles	6		

Mounting positions

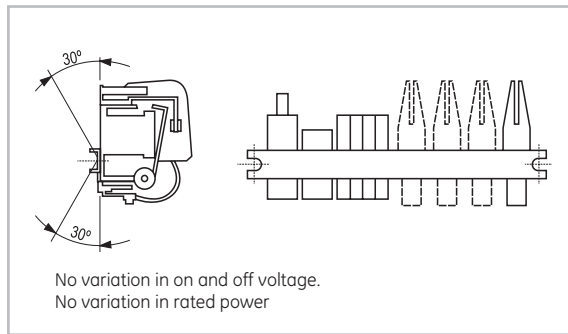

Maintenance

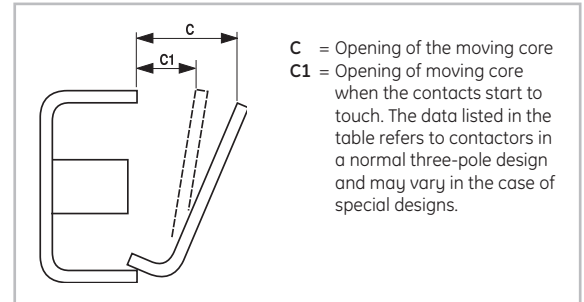

DC power supply		Pressure of closed contact in kg (+10% / -30%)
C (mm) ±1	C1 (mm) ±1	
18	5	0.750
18	5	0.750
20	6	0.750
22	6	1.300
24	7	2.000
28	8	3.500
28	8	5.500
34	10	8.000
34	10	15.000

Replacement of main contact

The replacement (due to wear) of the main contacts requires an adjustment to ensure proper distance between the moving and the stationary contacts. The respective adjustment screws should be turned until the main contacts start to touch simultaneously when the gap indicated by A1 or C1 exists between the stationary and the moving magnetic circuit. Make sure that all contactor poles have the same stroke by manually closing the magnetic circuit; if the poles are properly adjusted, they should come into contact at the same time.

If contact wear is abnormal, please contact the manufacturer since the apparatus has been improperly chosen for the application conditions. To replace the contacts, loosen the screw securing the contacts to the respective contact holder, making sure that the screws are well-tightened when installing the new contacts.

GE Power Controls warrants proper operation of the contactors only if the contacts are replaced with OEM contacts.

Capacity of terminals and torque

		R1... R2...	R3...	R4...	R5...	R6...	R7...	R8...	R9...
	Single-core conductor	(mm²)	2.5...25	2.5...50					
	Multi-strand conductor with terminal sheath	(mm²)	2.5...25	2.5...50					
	Multi-strand conductor without terminal sheath	(mm²)	2.5...25	2.5...50					
	Multi-strand	(mm²)	4...25	4...50					
	Single- and multi-strand AWG	(mm²)	16..4	16..2					
Torque	(Nm)		4	5,6					
	(Lb x in)		35	50					
	Multi-strand with terminal	(mm²)			1 x 120 2 x 95	1 x 185 2 x 150	-	-	-
	Clappers				-	-	2 x (30x5)	2 x (40x5)	2 x (60x5)
Torque	(Nm)				7	23	31	31	31
	(Lb x in)				60	200	275	275	275

Power circuit

		R1...	R2...	R3...	R4...	R5...	R6...	R7...	R8...	R9...
Thermal rated current I _{th} at $\theta \leq 55^\circ\text{C}$	(A)	45	90	125	250	320	450	630	800	1500
Rated operating current I _e AC-3	(A)	40	90	110	200	320	450	630	800	-
Rated operating voltage U _e (1)	(V)	500	500	500	500	500	500	500	500	500
3-pole contactors										
Rated isolation voltage U _i	(V)	1000	1000	1000	1000	1000	1000	1000	1000	1000
Maximum continuous current AC-1	(A)	45	90	125	250	320	450	630	800	1200
Frequency limits (Hz)	(Hz)									
Making capacity (RMS) (IEC947)	(A)	540	1200	1250	2400	3800	5400	7500	9600	4000
Breaking capacity (RMS) (IEC 947)	U _e ≤ 400V (A)	450	960	1250	1900	3050	4350	6000	7700	4000
	U _e = 500V (A)	-	650	1050	1900	3050	4350	6000	7700	4000
Short-time current	1 s. (A)	1200	1500	2000	2500	3000	4250	5000	6000	10000
	5 s. (A)	800	900	1500	2200	2800	4000	4800	5700	9000
	10 s. (A)	500	650	1200	1600	2500	3900	4600	5500	8800
	30 s. (A)	250	300	750	1100	2000	3700	4400	5200	8500
	1 min. (A)	180	200	450	800	1500	2500	3000	4000	5000
	3 min. (A)	100	150	250	500	600	900	1500	2300	3000
Recovery time	(min.)	10	10	10	10	10	10	10	10	10
Fused short-circuit protection	aM (A)	50	125	160	250	400	630	800	1000	-
	gL-gG (A)	80	160	200	315	425	630	800	1000	-
Impedance per pole	(mΩ)	1	1	0.5	0.4	0.2	0.3	0.2	0.25	0.10
Power dissipated per pole	AC-1 (W)	2.1	8.1	7.8	25	20	60	79	160	144
	AC-3 (W)	1.6	8.1	6	16	20	60	79	160	-
Isolation resistance	Pole-to-pole (mΩ)	>10	>10	>10	>10	>10	>10	>10	>10	>10
	Pole-to-ground (mΩ)	>10	>10	>10	>10	>10	>10	>10	>10	>10
	Input-to-output (mΩ)	>10	>10	>10	>10	>10	>10	>10	>10	>10

(1) For rated voltages above 500V, contact the manufacturer.

Control circuit

		R1...	R2...	R3...	R4...	R5...	R6...	R7...	R8...	R9...
Rated isolation voltage U _i	(V)	1000	1000	1000	1000	1000	1000	1000	1000	1000
Standardized voltages U _s at 50/60 Hz	(V)	24...220	24...220	24...220	24...220	24...220	24...220	24...220	24...220	24...220
Single-frequency coil voltage limits										
Operation	xU _s	0.85...1.1	0.85...1.1	0.85...1.1	0.85...1.1	0.85...1.1	0.85...1.1	0.85...1.1	0.85...1.1	0.85...1.1
Off	xU _s	0.22...0.55	0.22...0.55	0.22...0.55	0.22...0.55	0.22...0.55	0.22...0.55	0.22...0.55	0.22...0.55	0.22...0.55
Consumption of dual-frequency coils (1)										
Closed magnetic circuit (50 Hz/60 Hz)	(VA)	19	19	20	25	35	38	53	100	190
Open magnetic circuit (50 Hz/60 Hz)	(VA)	27	27	38	41	57	60	90	440	1400
Dissipated thermal power (50 Hz/60 Hz)	(W)	19	19	20	25	35	38	53	100	190
On and off times. Values at U _s										
Making time at de-energisation (NA)	(ms)	60/70	60/70	60/70	110/120	150/160	180/200	200/210	150/160	-
Making time at de-energisation (NA)	(ms)	80/95	80/95	80/95	160/170	200/210	350/450	240/250	150/160	-
Mechanical endurance										
Dual-frequency coils (at 50 Hz)	10 ⁶ ops.	10	10	10	10	10	10	10	8	8
Maximum rate										
Dual-frequency coils. No-load	ops./h	1200	1200	600	400	400	400	400	300	300
AC-1 with rated power	ops./h	600	600	300	120	120	120	120	90	60
AC-2 with rated power	ops./h	250	250	200	120	120	120	120	90	-
AC-3 with rated power	ops./h	600	600	300	120	120	120	120	90	-
AC-4 with rated power	ops./h	150	150	100	60	60	60	60	30	-
Direct current										
Rated isolation voltage U _i	(V)	1000	1000	1000	1000	1000	1000	1000	1000	1000
Standardized voltages U _s	(V)	24...230	24...230	24...230	24...230	24...230	24...230	24...230	24...230	24...230
Voltage limits										
Operating	xU _s	0.8...1.1	0.8...1.1	0.8...1.1	0.8...1.1	0.8...1.1	0.8...1.1	0.8...1.1	0.8...1.1	0.8...1.1
Off	xU _s	0.15...0.5	0.15...0.5	0.15...0.5	0.15...0.5	0.15...0.5	0.15...0.5	0.15...0.5	0.15...0.5	0.15...0.5
Power consumption										
Closed magnetic circuit	(W)	14	14	16	22	28	30	42	80	140
Open magnetic circuit	(W)	21	21	25	31	45	46	65	400	1000
On and off time										
Values at U _s										
Making time at energization (NA)	(ms)	60/70	60/70	60/70	110/120	150/160	180/200	200/210	150/160	-
Breaking time at de-energization (NA)	(ms)	19/20	19/20	19/20	28/30	40/45	59/60	30/35	25/30	-
Mechanical endurance	10 ⁶ ops.	10	10	10	10	10	10	10	8	8
Maximum rate										
No-load	ops./h	1200	1200	600	400	400	400	400	300	300
AC1 and AC3 with rated power	ops./h	600	600	300	120	120	120	120	90	-
AC4 with rated power	ops./h	150	150	100	60	60	60	60	30	-

(1) With 5/2 contact



Dimensional drawings

R1..., R2...

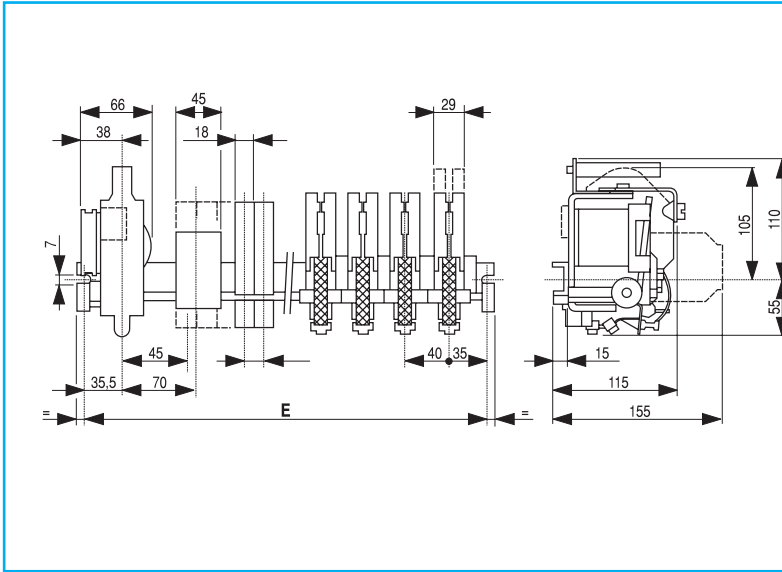

Contact combination

"Z" main pole (1)	Max. no. of aux. contacts	Max. NO	Max. NC	Center-to-center spacing
1	1	1	1	150
	3	3	3	200
	6	6	4	250
	9	6	4	300
	10	6	4	350
2	10	6	4	400
	1	1	1	200
	4	4	4	250
	7	6	4	300
	9	6	4	350
3	9	6	4	400
	2	2	2	250
	5	5	4	300
	7	6	4	350
	7	6	4	400
4	2	2	2	300
	5	5	4	350
	5	5	4	400

(1) A "RN" pole can be used to replace one of the "Z" poles. To use a higher number of "RN" poles, contact the manufacturer.

R3...

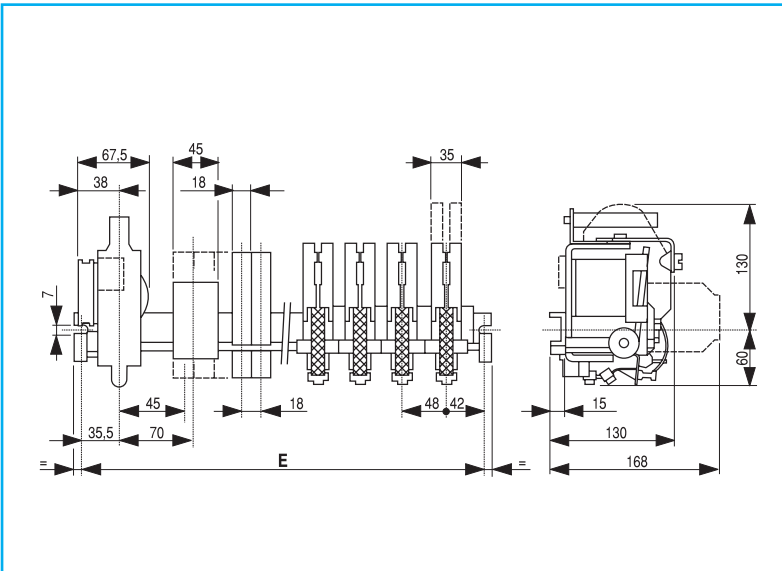

Contact combination

"Z" main pole (1)	Max. no. of aux. contacts	Max. NO	Max. NC	Center-to-center spacing
1	-	-	-	150
	3	3	3	200
	6	6	4	250
	9	6	4	300
	10	6	4	350
2	10	6	4	400
	-	-	-	200
	3	3	3	250
	6	6	4	300
3	8	6	4	350
	9	6	4	400
	-	-	-	250
	3	3	3	300
4	6	6	4	350
	7	6	4	400
	-	-	-	300
	3	3	3	350
4	4	4	4	400

(1) A "RN" pole can be used to replace one of the "Z" poles. To use a higher number of "RN" poles, contact the manufacturer.

R4...

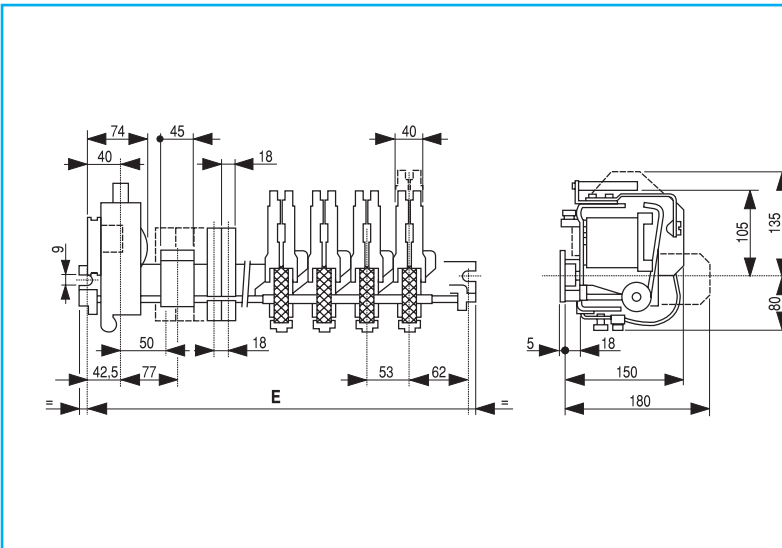

Contact combination

"Z" main pole (1)	Max. no. of aux. contacts	Max. NO	Max. NC	Center-to-center spacing
1	3	3	3	250
	6	6	4	300
	9	6	4	350
	10	6	4	400
	10	6	4	450
2	10	6	4	450
	-	-	-	250
	3	3	3	300
	6	6	4	350
	9	6	4	400
3	10	6	4	450
	-	-	-	300
	3	3	3	350
	6	6	4	400
4	9	6	4	450
	3	3	3	400
	4	4	3	450

(1) A "RN" pole can be used to replace one of the "Z" poles. To use a higher number of "RN" poles, contact the manufacturer.



R5...

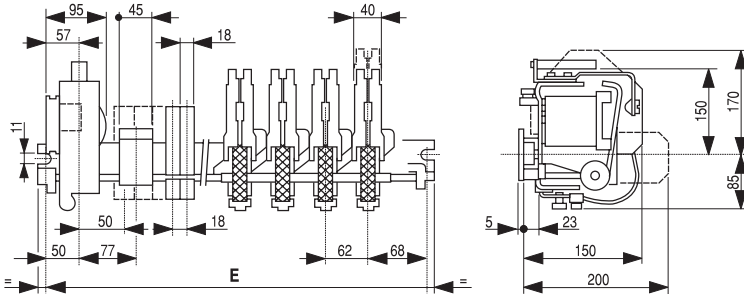

Contact combination

"Z" main pole (1)	Max. no. of aux. contacts	Max. NO	Max. NC	Center-to-center spacing
1	2	2	2	250
	5	5	4	300
	8	6	4	350
	10	6	4	400
	10	6	4	450
2	10	6	4	500
	2	2	2	300
	4	4	4	350
	7	6	4	400
3	10	6	4	450
	10	6	4	500
	1	-	-	350
	4	4	4	400
4	6	6	4	450
	7	6	4	500
	-	-	-	400
	3	3	3	450
	3	3	3	500

(1) A "RN" pole can be used to replace one of the "Z" poles. To use a higher number of "RN" poles, contact the manufacturer.

R6...

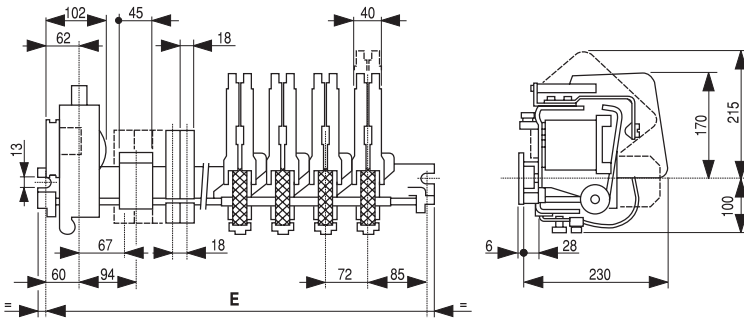

Contact combination

"Z" main pole	Max. no. of aux. contacts	Max. NO	Max. NC	Center-to-center spacing
1	5	2	4	350
	8	6	4	400
	10	6	4	450
	10	6	4	500
	10	6	4	600
2	10	6	4	700
	1	1	1	350
	4	4	4	400
	7	6	4	450
3	9	6	4	500
	10	6	4	600
	10	6	4	700
	2	2	2	450
4	5	5	4	500
	7	6	4	600
	7	6	4	700
	1	1	1	500
	2	2	2	600
	2	2	2	700

R7...

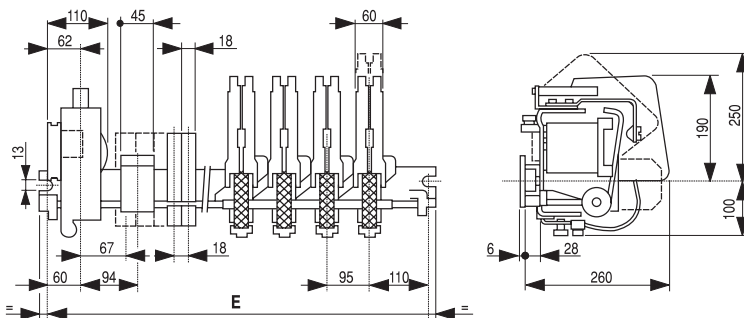

Contact combination

"Z" main pole (1)	Max. no. of aux. contacts	Max. NO	Max. NC	Center-to-center spacing
1	4	4	4	350
	6	6	4	400
	9	6	4	450
	10	6	4	500
	10	6	4	600
2	10	6	4	700
	1	1	1	400
	4	4	4	450
	7	6	4	500
3	10	6	4	600
	10	6	4	700
	1	1	1	500
	7	6	4	600
4	8	6	4	700
	2	2	2	600
	5	5	3	700

(1) A "RN" pole can be used to replace one of the "Z" poles. To use a higher number of "RN" poles, contact the manufacturer.

Dimensional drawings

R8...

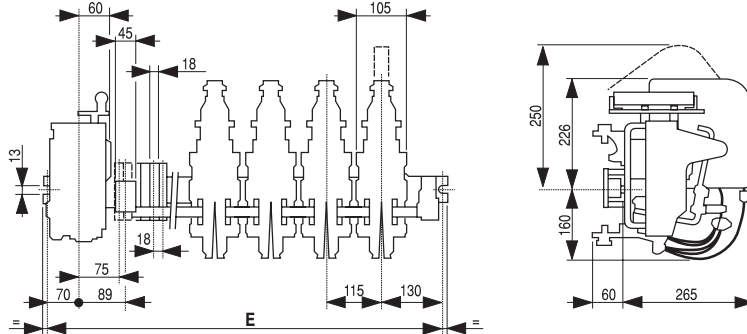

Contact combination

"Z" main pole	Max. no. of aux. contacts	Max. NO	Max. NC	Center-to-center spacing
1	1	1	1	350
	4	4	4	400
	6	6	4	450
	9	6	4	500
	10	6	4	600
	10	6	4	700
2	10	6	4	800
	-	-	-	450
	3	3	3	500
	8	6	4	600
3	10	6	4	700
	10	6	4	800
	2	2	2	600
4	8	6	4	700
	8	6	4	800
	1	1	1	700
	4	3	3	800

R9...

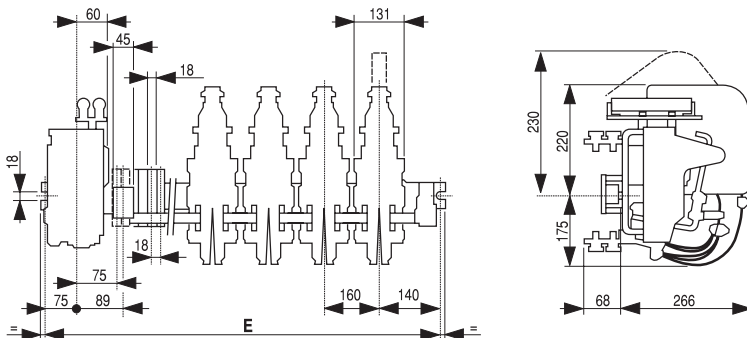

Contact combination

"Z" main pole	Max. no. of aux. contacts	Max. NO	Max. NC	Center-to-center spacing
1	2	2	2	400
	4	4	4	450
	7	6	4	500
	10	6	4	600
	10	6	4	700
	10	6	4	800
	10	6	4	900
	10	6	4	1000
2	4	4	4	600
	9	6	4	700
	10	6	4	800
	10	6	4	900
	10	6	4	1000
3	-	-	-	700
	6	6	4	800
	8	6	4	900
4	8	6	4	1000
	3	3	3	900
	4	3	3	1000